

Please read this manual carefully before installation and keep it for future reference.

Installation Manual



MRCOOL®

COMFORT MADE SIMPLE

MB176 Mini-Split Condenser Mounting Bracket

****CAUTION: The weight limit of this bracket is 176 lbs. *DO NOT* exceed**
this limit or serious injury or property damage may occur.**

Due to updates and constantly improving performance, the information and instructions within this manual are subject to change without notice. Please visit www.mrcool.com/documentation to ensure you have the latest version of this manual.

Version Date: 10-22-21

Thank you for choosing MRCOOL. Please read this manual carefully before installation and keep it for future reference.

Copyright © 2021 MRCOOL, LLC

!	Safety Precautions	2
1	Component Checklist	3
2	Assembly of Support Bracket Mounts	4
3	Installation Of The Bracket	5
4	Mounting the Air Conditioner	7

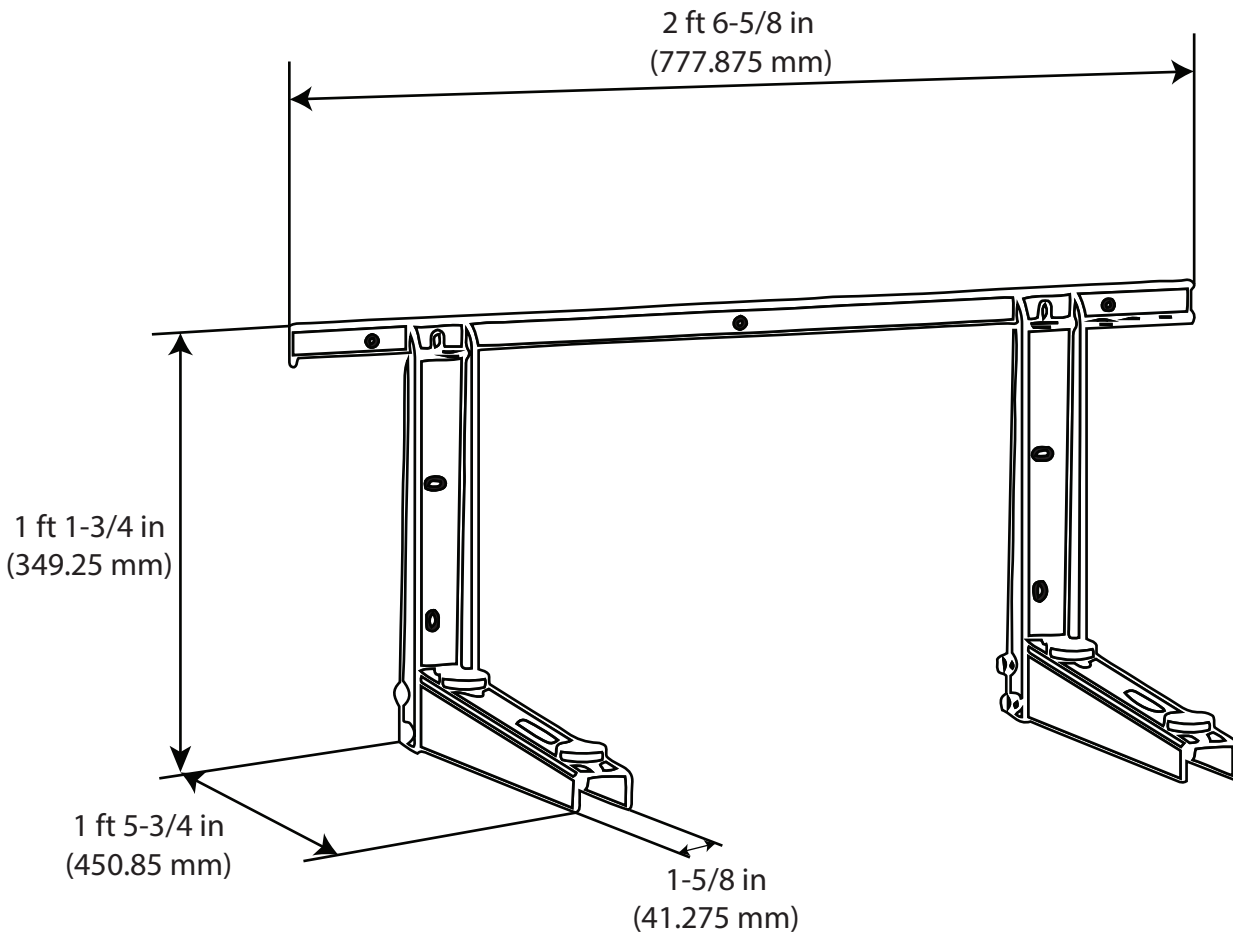

Safety Precautions



Read Before Using

Incorrect usage may cause serious damage or injury.

The seriousness of potential damage or injuries is classified as either a **WARNING** or **CAUTION**.



WARNING

This symbol indicates that ignoring instructions may cause death or serious injury.



CAUTION

This symbol indicates that ignoring instructions may cause moderate personal injury, damage to your unit, or property damage.



This symbol indicates that you should **NEVER** perform the indicated action.







WARNING

- This bracket is rated for a maximum weight of 176 lbs. (80 kg). **DO NOT exceed this limit.** If the rated weight limit is exceeded, serious property damage and/or personal injury may occur.
- This ductless mini-split condenser mounting bracket is intended for use only as specified. Improper usage may result in property damage and/or physical injury.
- Read the installation instructions fully and carefully before beginning product installation. If you have questions about the installation, please contact your dealer or MRCCOOL Support at 270-366-0457.
- The installation of this product requires basic mechanical skills and a full understanding of the installation manual. If you feel you are not comfortable performing this type of work, please seek a qualified professional.
- Before mounting the condenser bracket to the supporting surface, ensure the surface will support the combined weight of the bracket, condenser, and the attached components.
- To safely lift and position the bracket or condenser, an assistant or mechanical lifting equipment may be needed.
- When tightening mounting hardware (bolts, nuts, screws, etc.), **DO NOT** overtighten. Over tightening could cause long-term damage to the support bracket and weaken or reduce its weight capacity.
- The bracket is not intended for any use other than the support of a ductless mini-split condenser.
- Check the bracket every three months to ensure it remains securely fastened and safe to use.

Component Checklist

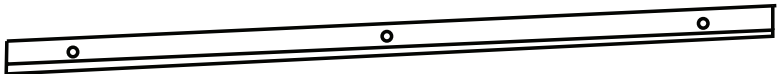
1

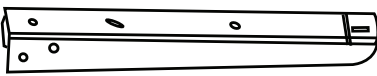
Before beginning installation, review all components to ensure the installation process can be completed successfully. If you find any parts are missing or faulty, please contact your dealer or MRCOOL Support at 270-366-0457.

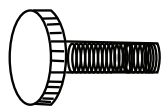
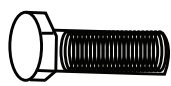
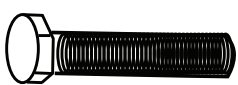
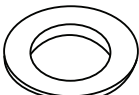
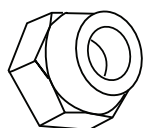
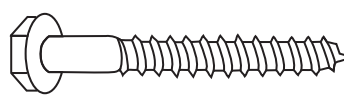
PART	LOOKS LIKE...	QUANTITY	
Wall Plate A		1	
Component B		4	
Component C		2	
Component D		2	
Component E		2	
PACKAGE M	Component M8x25 M-A		4
	Component M8X55 M-B		4
	Component D8 M-C		4
	Component M8 M-D		8
Component W-A		5	

Begin the installation process by assembling the support bracket mounts.

1. Take one of component C and one of component D. Using **Fig. 2.1** below as a guide, stand component C upright and insert component D into the bottom of component C. Make sure to align the four bolt holes (two on each side) at the bottom component C with the corresponding holes of component D. Component C and component D should be perpendicular from one another creating an "L" shape.
2. Insert two bolts (Component M8x55 M-B) completely through the holes and thread nuts (Component M8 M-D) onto the end of each of the bolts by hand. Then, using a wrench tighten the nuts until secure. ***DO NOT overtighten the nuts, as this could damage and possibly weaken the support bracket.***
3. Insert component E into the hole at base of the rear of component C. Please refer to **Fig 2.2**.
4. Next, take two bolts (component M8x25 M-A) and place washers (component B) onto them. Then, insert the bolts with washers into the front and rear slide holes on the top of component D. Next, put washers (component M-C) on the ends of each bolt and then secure with nuts (component M-D). ***DO NOT overtighten the nuts.*** Please refer to **Fig. 2.1**.
5. This completes the assembly of one support bracket mount. Repeat the same process for the second support bracket mount.

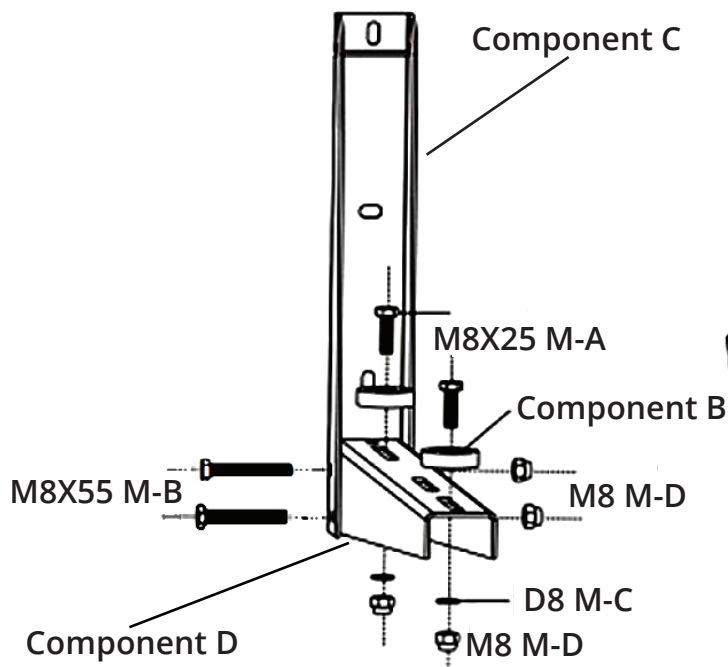
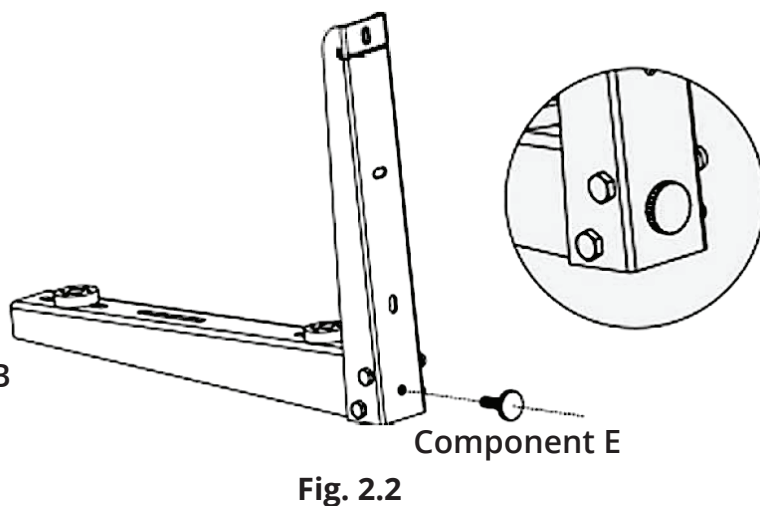

Fig. 2.1



Installation Of The Bracket

3

To properly install the bracket, you will need to select a strong and permanent installation location that can support the weight of the bracket and the condenser. Tools needed: Pencil (to mark mounting hole location), hand-held drill, and a level.

1. Using Wall Plate A (with lip of plate at the bottom), place it against the wall to determine the correct mounting location. Use a level to align the wall plate and ensure it is parallel with the ground. Once level, use a pencil to mark the three holes on the surface it is to be mounted to. Please refer to **Fig. 3.1**.
2. Once the holes are marked and aligned, using a hand-held drill with a 5/16 in (8 mm) drill bit, drill holes into the mounting surface with a depth of approximately 2-3/4 in (70 mm).

NOTE: If you are drilling into any type of masonry (concrete, brick, etc.) please use a masonry drill bit which is specifically made to drill into those types of materials.

3. Then, place the wall plate against the wall and align the mounting holes. Insert the bolts, component W-A, through the wall plate and into the mounting holes. Tighten the bolts to secure the wall plate to the mounting surface. ***DO NOT* overtighten the bolts.**

Component W-A



4. Now, using the support bracket mounts you assembled in the first section, you will now slide them onto each side of the mounted wall plate. They will need to be slid into the correct position on the wall plate to accommodate the bottom of the condenser. Please refer to **Fig. 3.1**.

NOTE: Various size condensers can mount to this bracket. The bracket support mounts have the ability to slide on the wall plate to fit your application. It is important to determine where the support bracket mounts should be mounted before proceeding to the next step.

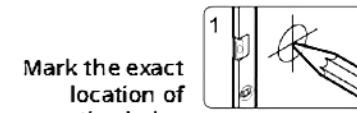
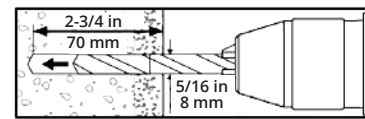
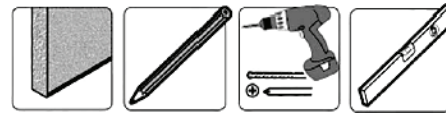

Mark the exact location of mounting holes

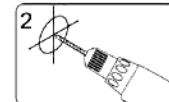

Drill pilot holes



Level Reading



Bolt the wall mount onto the wall

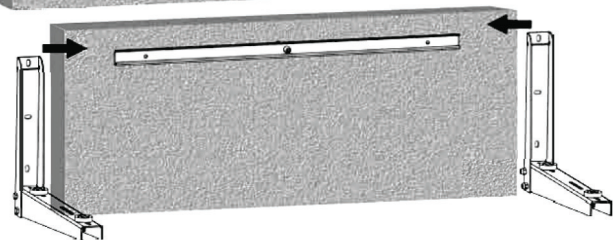
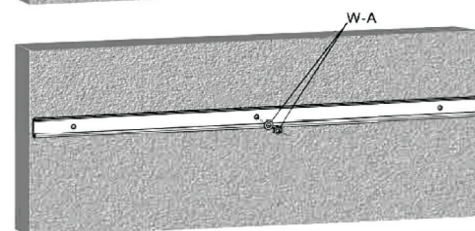
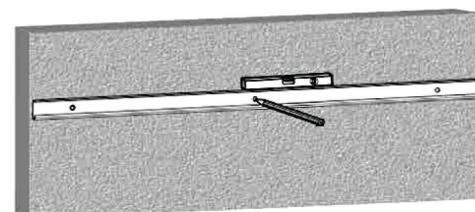
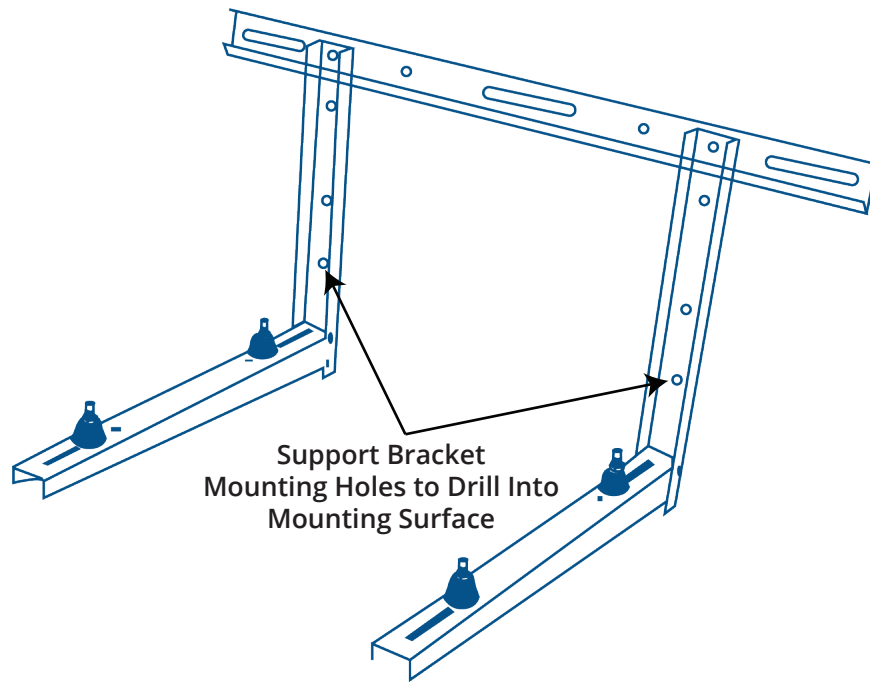

Fig. 3.1

Installation Of The Bracket

5. With the support bracket mounts in the correct position, you will now use a pencil to mark the bottom hole on each of the support mounts. Once marked, remove the support bracket mounts from the wall plate. Refer to the image below.



NOTE: Component E, that you installed earlier in the installation, is actually a vertical leveling screw. If you are mounting the bracket to a wall that has an uneven exterior surface (such as vinyl siding), and find that the upright portion of the bracket (component C) does not sit vertically straight against the wall, you can use this screw to adjust it. It acts as a bumper that sits against the wall and can be adjusted in and out. Please refer to the image below.

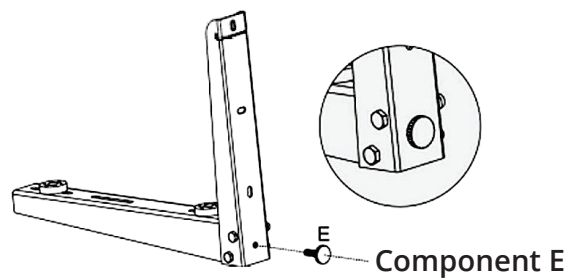

6. You will now drill the holes you just marked on the mounting surface using the same drill bit and drill depth used when mounting the wall plate.
7. Then, slide the support bracket mounts back on the wall plate and align the mounting holes. Now, insert the bolts from component W-A into the mounting holes and tighten them. ***DO NOT* overtighten the bolts.**

CAUTION

Installers must verify that the supporting surface will safely support the combined weight of the equipment and all attached hardware and components.

NOTE On Mounting the Condenser to the Bracket

If the MRCOOL® condenser that is to be installed to the bracket has rubber pads on the bottom of the mounting feet, remove them before attempting to mount the condenser to the bracket. The bracket has rubber isolating pads that will take the place of these.

1. Slowly position the unit on the installed mounting bracket and make sure it is firmly supported by the mounting bracket.

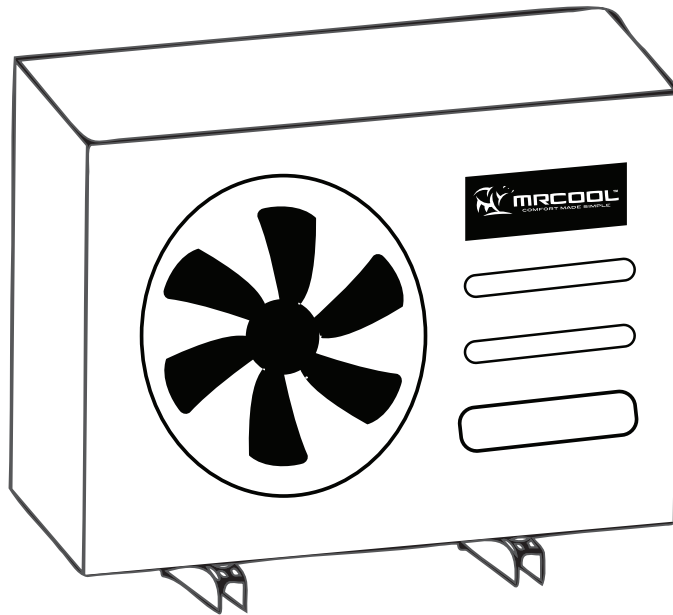

Disclaimer: Air Conditioner is not included with bracket.

Maintenance

- Check that the bracket is securely fastened and safe to use at regular intervals.
- Please contact your distributor if you have any questions.



MRCOOL®

COMFORT MADE SIMPLE

MB176 Mini-Split
Condenser Mounting Bracket

The design and specifications of this product and/or manual are subject to change without prior notice. Consult with the sales agency or manufacturer for details.