

This product utilizes R-454B refrigerant

Versa Pro[®] & Hyper Heat Heat Kit Installation & Owner's Manual

MODELS:

MVPHK**

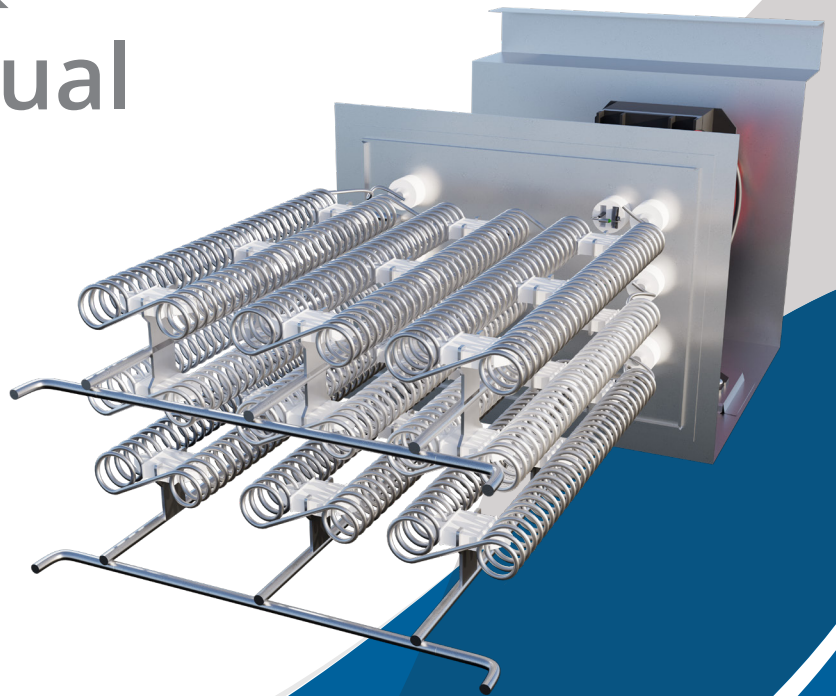

Read this manual carefully before installation and keep it where the operator can easily find it for future reference.

Due to updates and constantly improving performance, the information and instructions within this manual are subject to change without notice.

Version Date: January 27, 2025
Please visit www.mrcool.com/documentation
to ensure you have the latest version of this manual.



CONTENTS

1	SAFETY	1
2	INSTALLATION	2
3	ELECTRICAL SPECIFICATIONS	4

Safety Precautions

Read Before Using

Incorrect usage may cause serious damage or injury.

The symbols below are used throughout this manual to indicate instructions that should be followed closely or actions that should be avoided to prevent death, injury, and/or property damage.



Indicates a medium level of risk which, if not avoided, may result in death or serious injury.



Indicates a low degree of risk which, if not avoided, may result in minor or moderate injury.

NOTICE

Indicates important information but not danger.

WARNING

1. Turn off the device and disconnect the power before performing any installation, cleaning, or repairs. Failure to do this could result in electrical shock.
2. This appliance is not intended for use by persons (including children) with reduced physical, sensory, or mental capabilities, or lack of experience or knowledge, unless they have been given supervision or instruction concerning use of the appliance by a person responsible for their safety. Children should be supervised to ensure that they do not play with the appliance.

ELECTRICAL WARNINGS

1. The product must be properly grounded during installation or electrical shock could occur.
2. For all electrical work, follow all local and national wiring standards, regulations, and the installation manual. Connect cables tightly and clamp them securely to prevent external forces from damaging the terminal. Improper electrical connections could overheat, causing fire and/or electrical shock.
3. All electrical connections must be made according to the Electrical Connection Diagram located on the panels of the indoor and outdoor units.
4. If connecting power to fixed wiring, an all-pole disconnection device must be incorporated in the fixed wiring in accordance with the wiring rules and must meet the following requirements: at least 3 mm of clearances in all poles, a leakage current that may exceed 10 mA, and a residual current device (RCD) having a rated residual operating current not exceeding 30 mA.
5. All wiring must be properly arranged to ensure that the control board cover can close properly. If the control board cover is not properly closed, it can lead to corrosion and cause the connection points on the terminal to heat up, catch fire, or cause electrical shock.

! WARNINGS FOR PRODUCT INSTALLATION

INSTALLATION MUST BE PERFORMED BY AN AUTHORIZED DEALER OR SPECIALIST. DEFECTIVE INSTALLATION CAN CAUSE WATER LEAKAGE, ELECTRICAL SHOCK, OR FIRE.

******ELECTRICAL WORK MUST BE COMPLETED BY A QUALIFIED ELECTRICAL TECHNICIAN******

- ⚠ **DO NOT** install the unit in a location that may be exposed to combustible gas leaks. If combustible gas accumulates around the unit, it could cause fire.
 - ⚠ **DO NOT** turn on the power until the installation and all work has been completed.
 - ⚠ **DO NOT** install a unit equipped with an auxiliary electric heater within 3 ft (1 m) of any combustible materials.
1. Installation must be performed according to the installation instructions. Improper installation could cause water leakage, electrical shock, fire, and could void the warranty. Contact an authorized service technician for repair or maintenance of this unit. This appliance must be installed in accordance with national wiring regulations.
 2. Only use the included accessories, parts, and specified parts for installation. Using non-standard parts can cause water leakage, electrical shock, fire, and/or failure of the unit.
 3. When moving or relocating the air conditioner, consult experienced service technicians for disconnection and re-installation of the unit.

Accessories

Name	Quantity
Manual	1
Foam Gasket	2
Screws	7
Silicone Breaker Cover	1
Electric Auxiliary Heating Wiring Diagram	1
Circuit Breaker Label	1

Model Size Selection

For installations requiring supplemental heating, the optional Electric Auxiliary Heat Module is available in sizes from 5kW to 25kW to accommodate appropriate sizing given the specific heat load and electrical requirements of each installation. Refer to the table below for selection of available sizes of each model, being sure to avoid improper matching.

Model (Btu/h)	5kW	8kW	10kW	15kW	20kW
18K	Y	Y	Y	-	-
24K	Y	Y	Y	Y	-
30K	Y	Y	Y	Y	-
36K	Y	Y	Y	Y	Y
48K	-	Y	Y	Y	Y
60K	-	-	Y	Y	Y

Only use compatible modules certified for use with the model. Refer to the Electric Auxiliary Heat Model specification for additional details to ensure proper selection and installation.

Installation Preparation

Before installation, confirm the electric auxiliary heat module and supplied accessories are present and free of damage. Do not attempt to install if damage is present.

Electric Auxiliary Heat Module Installation and Wiring Operation

Step 1:

Open the upper cover.

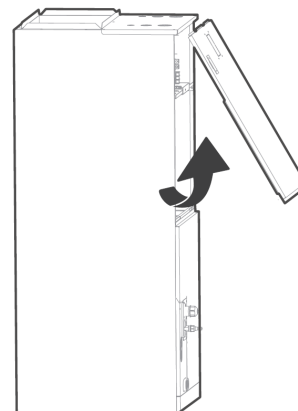

Step 2:

Use tools to remove the knock-out holes of the upper cover.

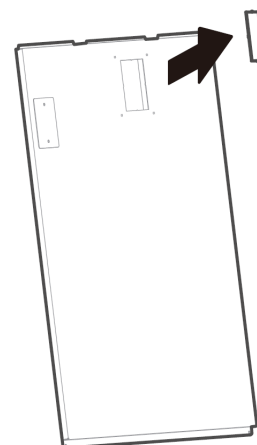

2 INSTALLATION

Step 3:

Remove the terminal block and power wires, loosen the screws, and remove the electric auxiliary heating cover.

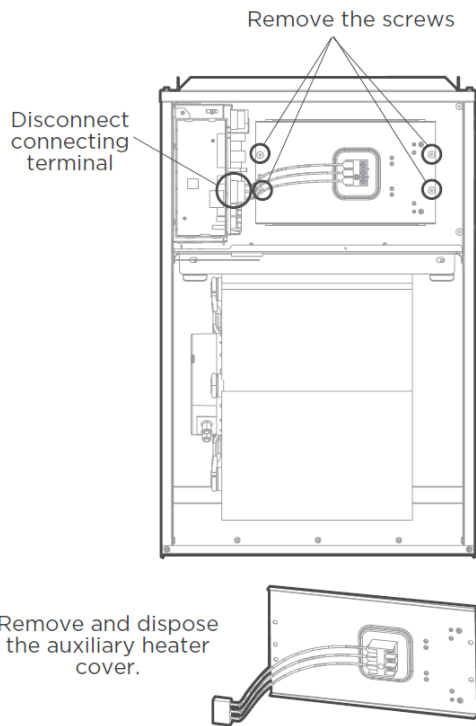

Step 4:

Install the electric auxiliary heating assembly through the front, and note that the support assembly must lock into the support holes in the back of the cabinet.

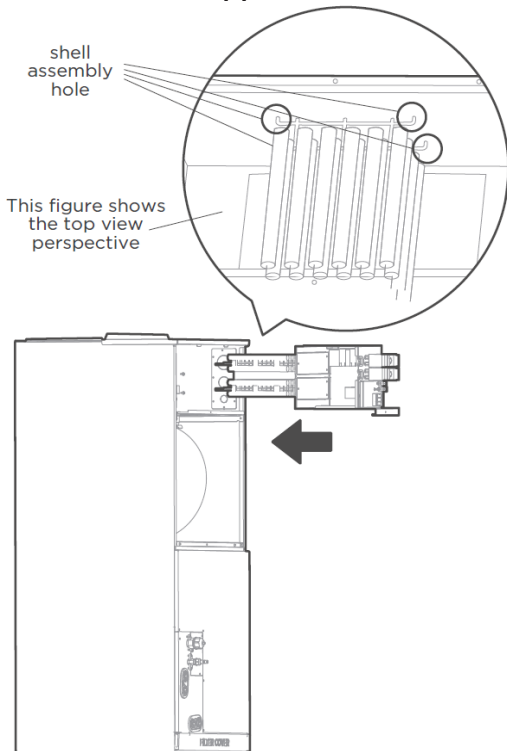

Step 5:

Tighten the mounting screws.

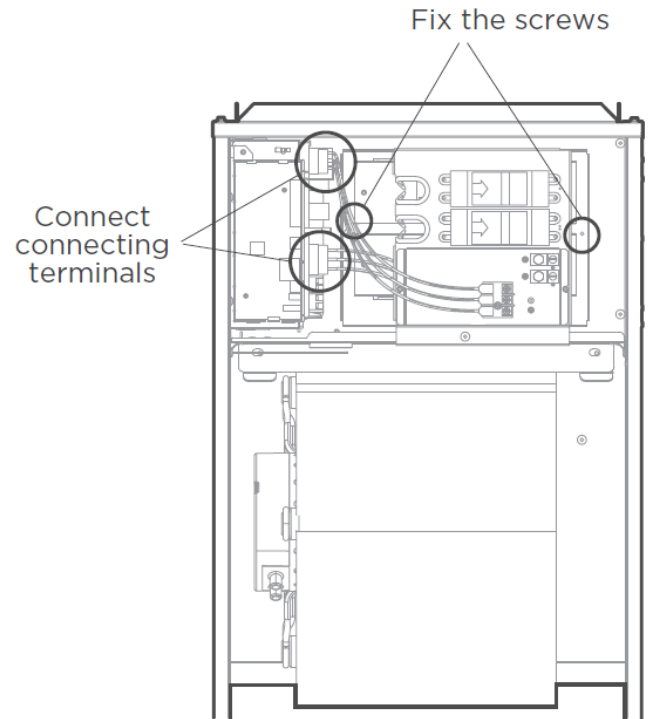

Step 6:

Wire according to the wiring nameplate. Apply the wiring diagram to the inside cover for future reference and maintenance.

Step 7:

Install the upper cover and the silicone breaker cover.

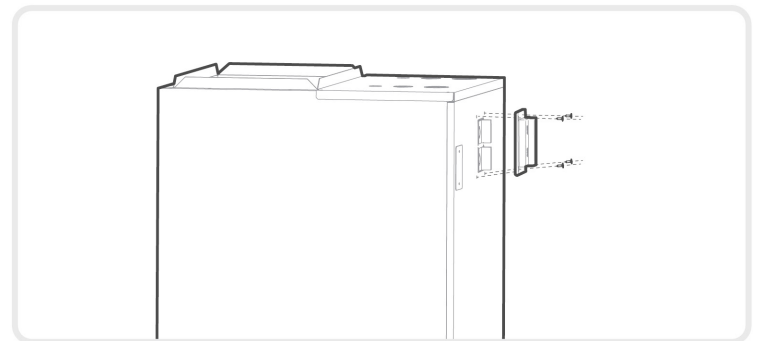

Step 8:

After installing the electric auxiliary heat module, apply the circuit breaker label near the silicone breaker cover previously installed.

NOTICE

- The electric auxiliary heating wiring diagram is packed with the accessories.
- If the branch circuit wire length exceeds 100ft, consult NEC 210-19a to determine maximum wire length.
- Use 2% voltage drop.

After the electric heating wiring is connected, please confirm the following before powering on:

- Check and ensure a secure connection of all wiring.
- Ensure that wire size is properly selected per NEC or local codes.

Model	Number of Circuit Breakers	Number of Relays	Number of Power Cord Groups	Number of Power Cord Grounding Screws
5kW	1	1	2	2
8kW	1	2	2	2
10kW	1	2	2	2
15kW	2	3	3	3
20kW	2	4	3	3

Use copper wire only to connect unit. If other than uncoated (non-plated) 75°C copper wire (solid wire for 10 AWG and smaller, stranded wire for larger than 10 AWG) is used, consult applicable tables of the National Electric Code (ANSI/NFPA 70).

NOTICE

The specification may be different between different models. Refer to the indoor unit's nameplate. Choose the cable type according to the local electrical codes and regulations. Choose the correct cable size according to the Minimum Circuit Ampacity indicated on the nameplate of the unit.

Heater Model	Heater kW	Internal Circuit Protection	Circuit 1 208/230V			Circuit 2			Circuit 2		
			Heater Amps	MCA (1)	MOP (2)	Heater Amps	MCA (1)	MOP (2)	Heater Amps	MCA (1)	MOP (2)
MVPHK05	5	Ckt Bkr	18.0/20.0	23.0/27.0	25.0/30.0	/	/	/	/	/	/
MVPHK08	8	Ckt Bkr	28.8/32.0	37.0/42.0	40.0/45.0	/	/	/	/	/	/
MVPHK10	10	Ckt Bkr	36.0/40.0	46.0/53.0	50.0/60.0	/	/	/	/	/	/
MVPHK15	15	Ckt Bkr	18.0/20.0	23.0/27.0	25.0/30.0	36.0/40.0	46.0/53.0	50.0/60.0	/	/	/
MVPHK20	20	Ckt Bkr	36.0/40.0	46.0/53.0	50.0/60.0	36.0/40.0	46.0/53.0	50.0/60.0	/	/	/

3 ELECTRICAL SPECIFICATIONS

5KW HEAT KIT

-  : THERMAL LINK
-  : THERMAL CUT-OUT, SELF-RESETTING

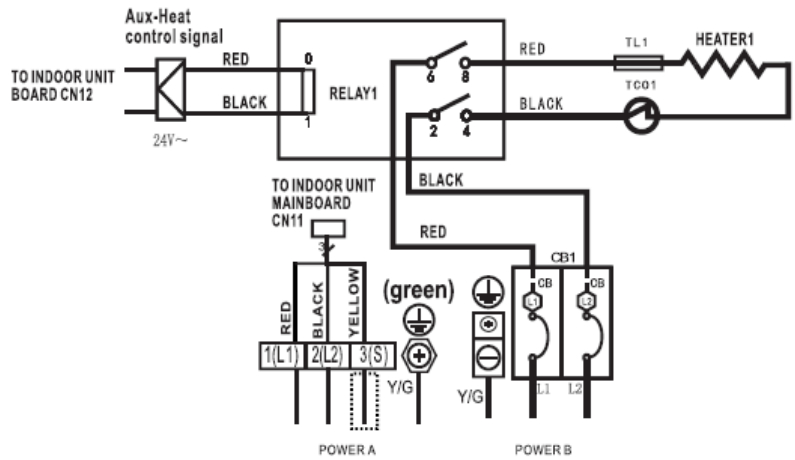

NOTE1: 







This symbol indicates the element is optional. The wiring type of the actual unit shall prevail.

NOTE2:

PLEASE ATTACH THE NAMEPLATE TO THE COVER OF THE ELECTRIC CONTROL BOX. ALL THE ROUND HOLES LOCATED ON THE PLATE REPRESENT NUMBERS. PLEASE REFER TO THE INSTALLATION MANUAL FOR DETAILS.

NOTE3: TO BE WIRED IN ACCORDANCE WITH NEC AND LOCAL CODES.

NOTE4: POWER A,B,C,D ARE DIFFERENT POWERS.

Round hole number	Relay number	Round hole number	Circuit breaker number
	RELAY 1		CB1
			
			
			
			

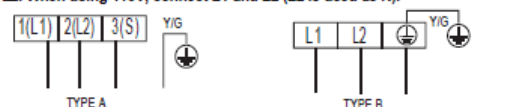

The wiring mode of power supply A shall be based on the type of original wiring terminal of AHU; for type A, S position must be connected to the outdoor S; for type B, S position shall not be connected. When using 208V or 230V, connect L1 and L2. When using 115V, connect L1 and L2 (L2 is used as N).



TYPE A: 1(L1) 2(L2) 3(S) Y/G

TYPE B: L1 L2 Y/G

8KW/10KW HEAT KIT

-  : THERMAL LINK
-  : THERMAL CUT-OUT, SELF-RESETTING

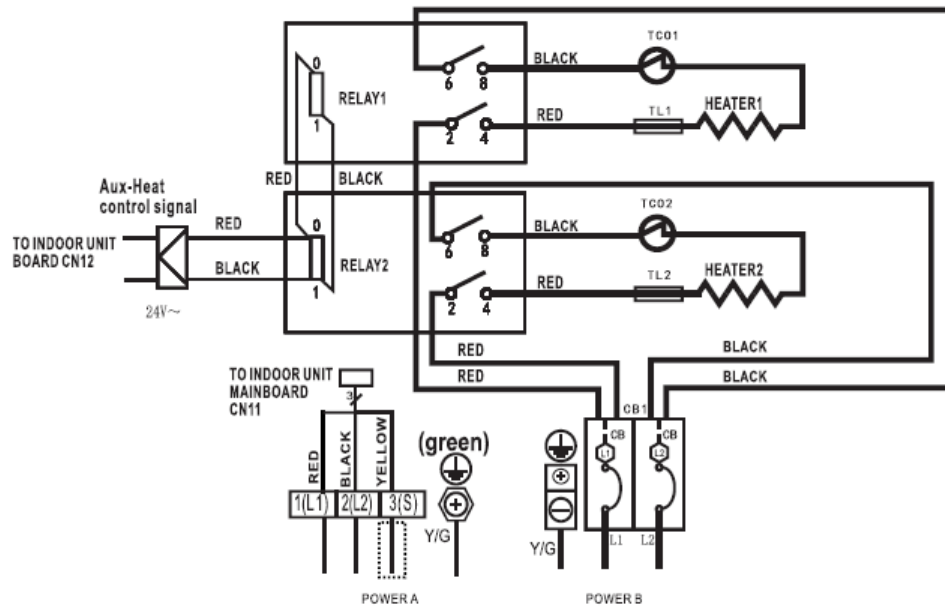

NOTE1: 







This symbol indicates the element is optional, The wiring type of the actual unit shall prevail.

NOTE2:

PLEASE ATTACH THE NAMEPLATE TO THE COVER OF THE ELECTRIC CONTROL BOX. ALL THE ROUND HOLES LOCATED ON THE PLATE REPRESENT NUMBERS. PLEASE REFER TO THE INSTALLATION MANUAL FOR DETAILS.

NOTE3: TO BE WIRED IN ACCORDANCE WITH NEC AND LOCAL CODES.

NOTE4: POWER A,B,C,D ARE DIFFERENT POWERS.



Round hole number	Relay number	Round hole number	Circuit breaker number
	RELAY 1		CB1
	RELAY 2		
			
			
			

The wiring mode of power supply A shall be based on the type of original wiring terminal of AHU; for type A, S position must be connected to the outdoor S; for type B, S position shall not be connected. When using 208V or 230V, connect L1 and L2. When using 115V, connect L1 and L2 (L2 is used as N).



3 ELECTRICAL SPECIFICATIONS

15KW HEAT KIT

-  : THERMAL LINK
-  : THERMAL CUT-OUT, SELF-RESETTING

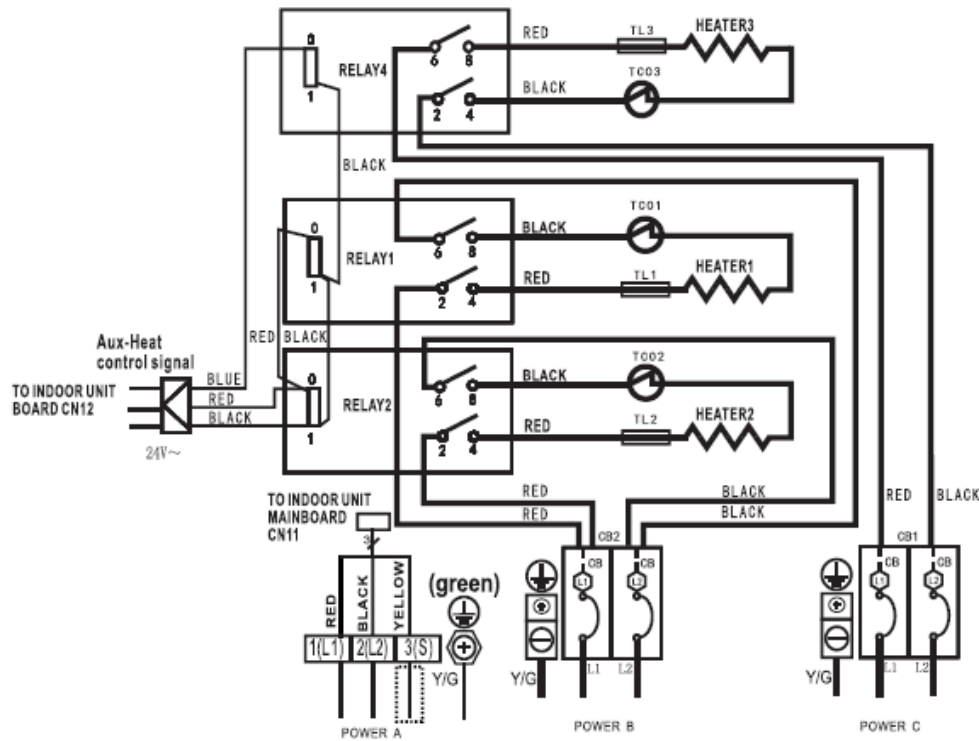







NOTE1:  This symbol indicates the element is optional. The wiring type of the actual unit shall prevail.

NOTE2: PLEASE ATTACH THE NAMEPLATE TO THE COVER OF THE ELECTRIC CONTROL BOX. ALL THE ROUND HOLES LOCATED ON THE PLATE REPRESENT NUMBERS. PLEASE REFER TO THE INSTALLATION MANUAL FOR DETAILS.

NOTE3: TO BE WIRED IN ACCORDANCE WITH NEC AND LOCAL CODES.

NOTE4: POWER A,B,C,D ARE DIFFERENT POWERS.

Round hole number	Relay number	Round hole number	Circuit breaker number
	RELAY 1		CB1
	RELAY 2		CB2
			
	RELAY 4		
			

The wiring mode of power supply A shall be based on the type of original wiring terminal of AHU; for type A, S position must be connected to the outdoor S; for type B, S position shall not be connected. When using 208V or 230V, connect L1 and L2. When using 115V, connect L1 and L2 (L2 is used as N).



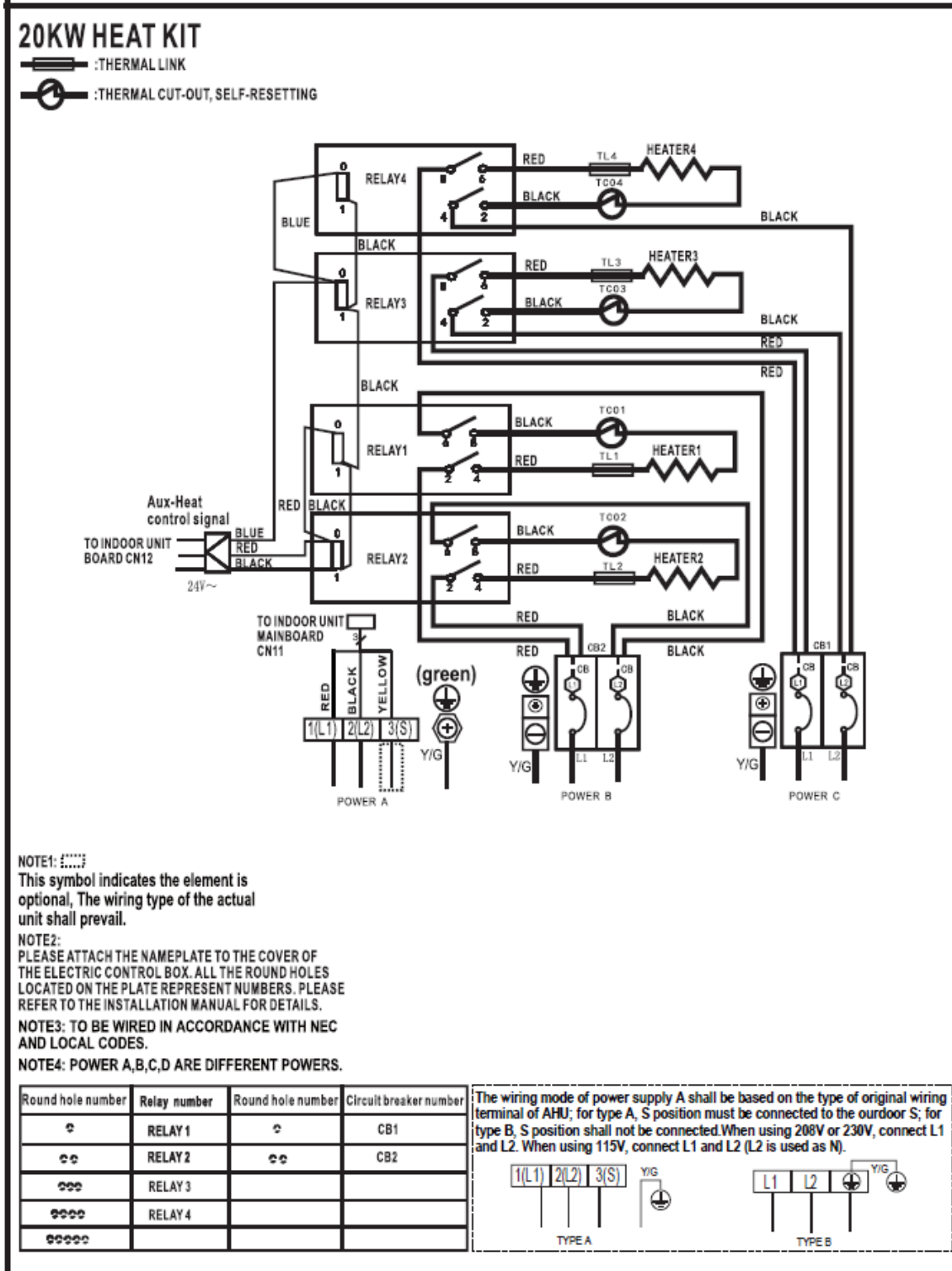



MRCOOL®
COMFORT MADE SIMPLE

Versa Pro® & Hyper Heat Heat Kit

The design and specifications of this product and/or manual are subject to change without prior notice.
Consult with the sales agency or manufacturer for details.